



TYPHOON INTAKE SYSTEMS

INTAKE SYSTEMS FOR VEHICLES LISTED ARE 50 STATE LEGAL. SEE KNFILTERS.COM FOR CARB STATUS ON EACH PART FOR A SPECIFIC VEHICLE.

INSTALLATION INSTRUCTIONS

69-8520TS
69-8520TR
TOYOTA
2000-04 Celica GT
L4-1.8L

TOOLS NEEDED:

- Phillips screwdriver
- Flathead screwdriver
- Ratchet
- 10mm socket
- 2.5mm allen wrench
- 3mm allen wrench
- 4mm allen wrench
- Pliers

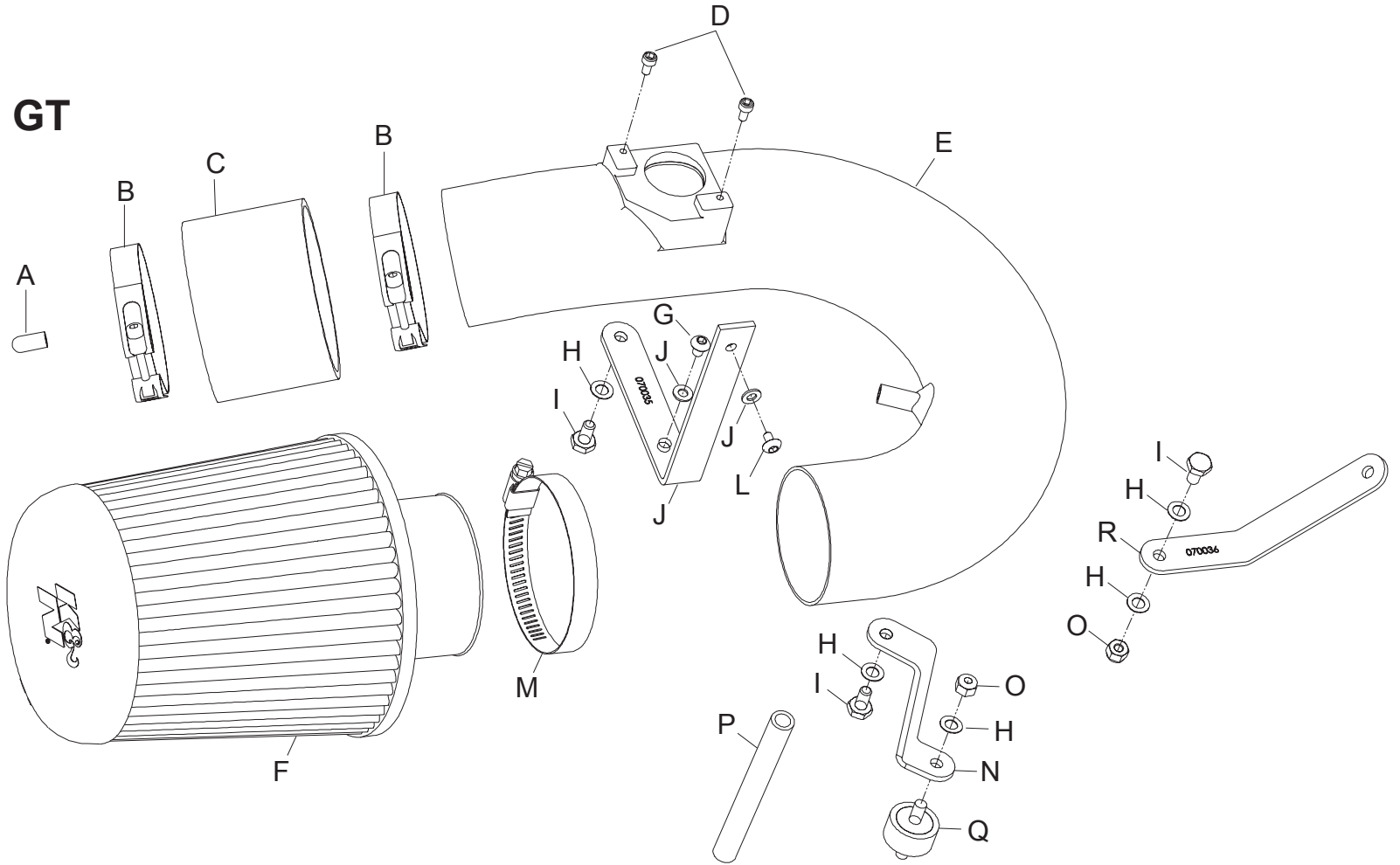

PARTS LIST:

Description	Qty.	Part #	Description	Qty.	Part #	Description	Qty.	Part #
A Rubber Cap	1	08282	G Screw, 5mm x 8mm L. bttnd	1	07740	M Hose Clamp, #44	1	08560
B Hose Clamp, #44	2	08560	H 6mm Wave Washer	5	08277	N "Z" Bracket	1	070038
C Silicone Hose, Black	1	08440	I Hex Bolt, 6mm x 12mm L.	3	07727	O 6mm Nylock Nut	2	07512
D Cap Screw, 4mm x 8mm L.	2	07733	J 5mm Flat Washer	2	08212	P Hose, 8mm x 4-1/2" L.	1	08074
E Intake Tube	1	27075	K "L" Bracket, Large	1	070035	Q 6mm Rubber Mounted Stud	1	07027
F Air Filter	1	RU-4870	L Screw, 4mm x 8mm L. bttnd	1	07741	R "L" Bracket, Small	1	070036

NOTE: FAILURE TO FOLLOW INSTALLATION INSTRUCTIONS AND NOT USING THE PROVIDED HARDWARE MAY DAMAGE THE INTAKE TUBE, THROTTLE BODY AND ENGINE.

TO START:

1. Turn off the ignition and disconnect the negative battery cable.

NOTE: Disconnecting the negative battery cable erases pre-programmed electronic memories. Write down all memory settings before disconnecting the negative battery cable. Some radios will require an anti-theft code to be entered after the battery is reconnected. The anti-theft code is typically supplied with your owner's manual. In the event your vehicles' anti-theft code cannot be recovered, contact an authorized dealership to obtain your vehicles anti-theft code.

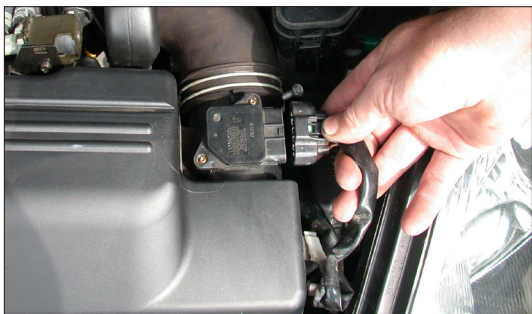

2. Disconnect the mass air sensor electrical connection.

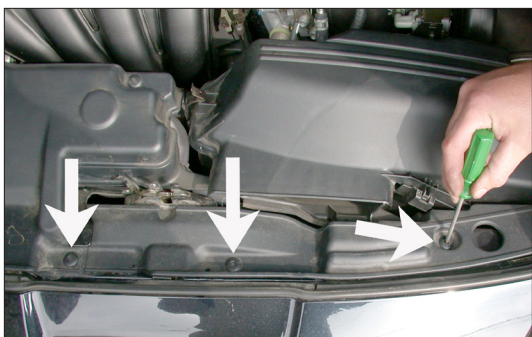

3. Depress the center pins on the push clips on the radiator core support cover as shown.



4. Remove the radiator core support cover as shown.



5. Unclip the relay and fuse box and move it out of the way as shown.

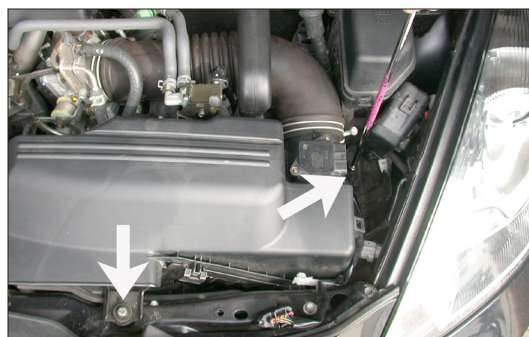

6. Loosen and remove the bolts that secure the air cleaner assembly as shown.



7. Unclip the PWM vacuum switching valve from the rear of the air cleaner assembly as shown.



8. Pull firmly to remove the computer fresh air tube as shown.



9. Loosen the hose clamps on the stock intake tube, then, remove the stock intake tube as shown.

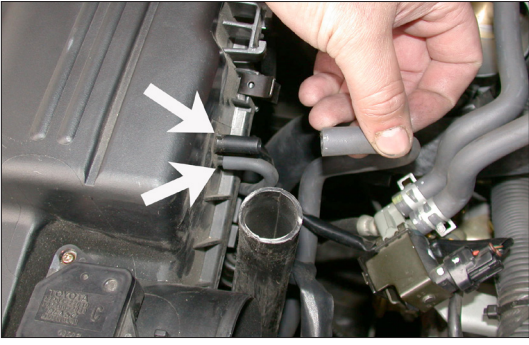

10. Remove the two stock rubber hoses from the air cleaner lid as shown.

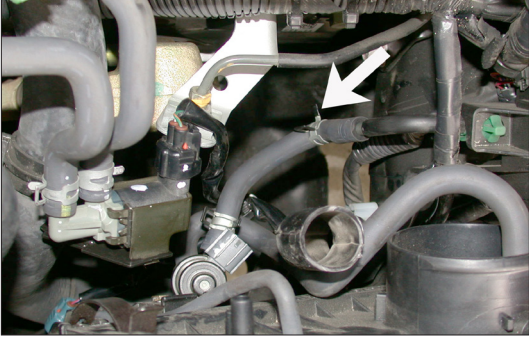

11. Remove the EVAP OBD canister closed valve vent hose from the hard line as shown.

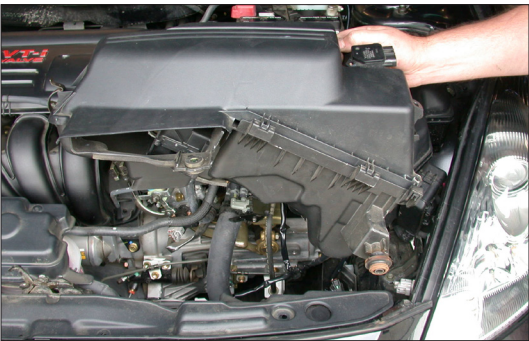

12. Push back, and pull up to gain access to the bottom of the air cleaner assembly as shown.
NOTE: K&N Engineering, Inc., recommends that customers do not discard factory air intake.

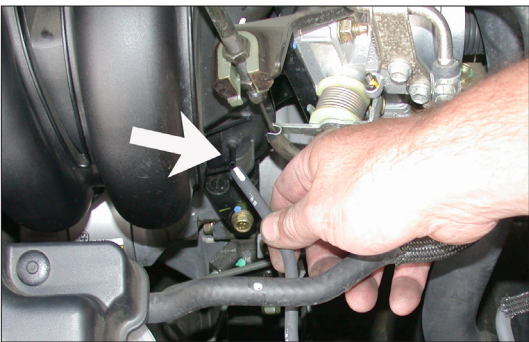

13. Remove the vacuum hose from the intake manifold as shown.



14. Disconnect the vacuum switching valve electrical connection as shown.

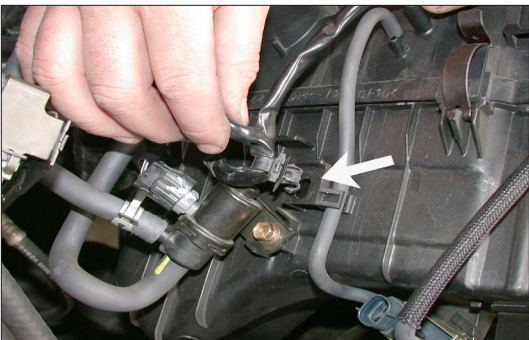

15. Using a pair of pliers unclip the wire harness from the back of the air cleaner assembly as shown.

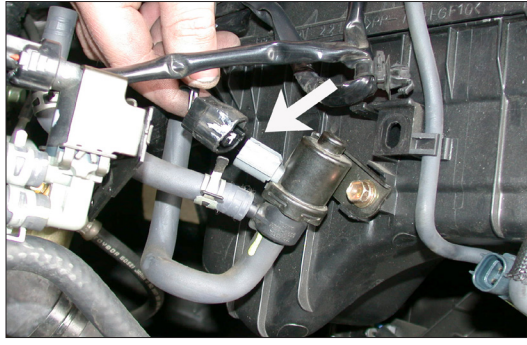

16. Disconnect the EVAP OBD canister closed valve electrical connection as shown.



17. Remove the complete air cleaner assembly as shown.

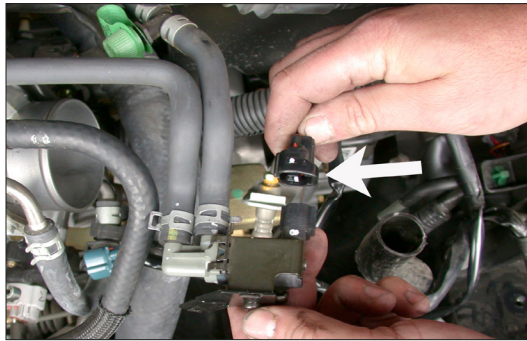

18. Disconnect the PWM vacuum switching valve electrical connection as shown.



19. Remove the stock bracket from the PWM vacuum switching valve as shown.



20. Remove the mass air sensor from the air cleaner assembly as shown.

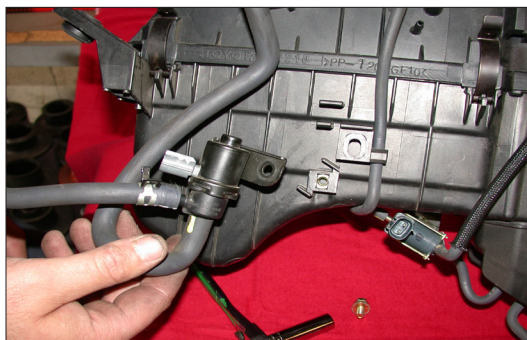

21. Loosen and remove the EVAP OBD canister closed valve from the air cleaner assembly as shown.

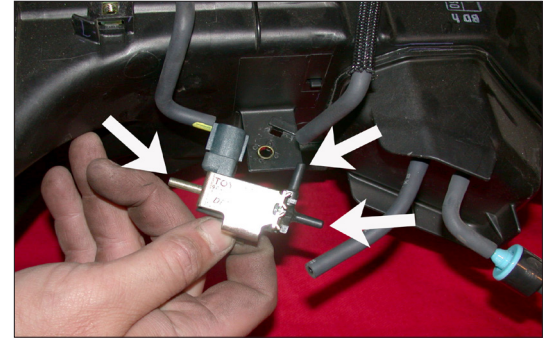

22. Disconnect the vacuum hoses from the vacuum switching valve, then, remove the vacuum switching valve from the bottom of the air cleaner assembly as shown.



23. Remove the two vent hoses from the EVAP OBD canister closed valve as shown.



24. Secure the EVAP OBD canister closed valve to the provided angle bracket using the provided hardware as shown.



25. Secure the vacuum switching valve to the provided "L" bracket using the provided hardware as shown.



26. Secure the "Z" bracket to the threaded boss on the Typhoon intake tube using the provided hardware as shown.
NOTE: Before installing the "Z" bracket, inspect the inside of the tube for any debris, then clean the inside out with water and a towel. Inspect the tube one more time before proceeding to the next step.

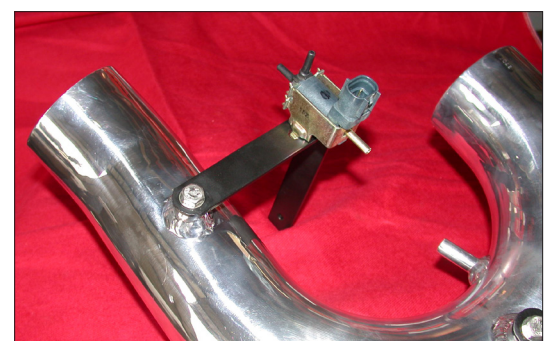

27. Secure the "L" bracket to the threaded boss on the Typhoon intake tube using the provided hardware as shown.



28. Install the mass air sensor into the intake tube and secure using the provided hardware as shown.

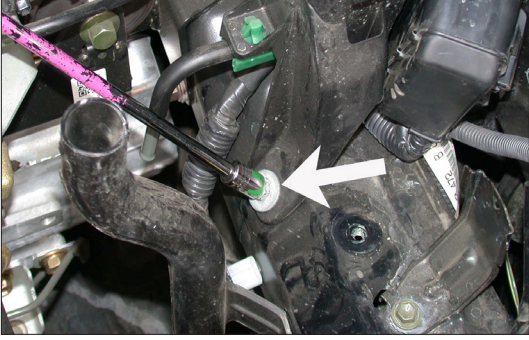

29. Loosen and remove the stock nut on the relay and fuse box support bracket as shown.

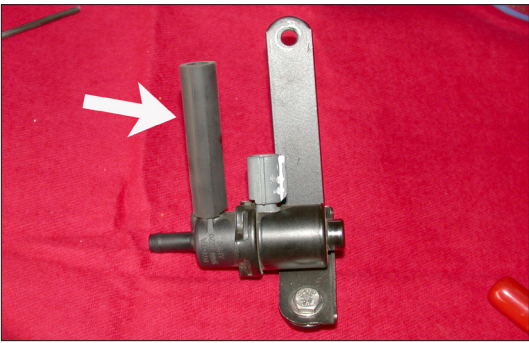

30. Connect the provided silicone hose onto the EVAP OBD canister closed valve as shown.

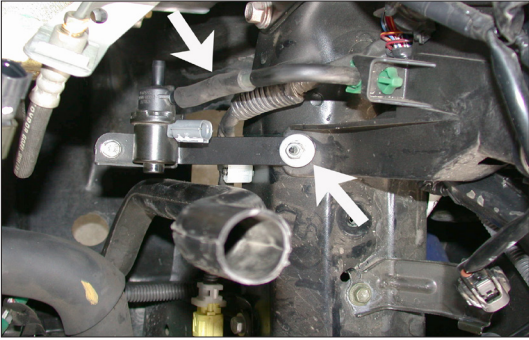

31. Install the EVAP OBD canister closed valve assembly into the vehicle and connect the hose to the hard line, then, secure the bracket to the relay and fuse box support bracket using the nut removed in step 29.

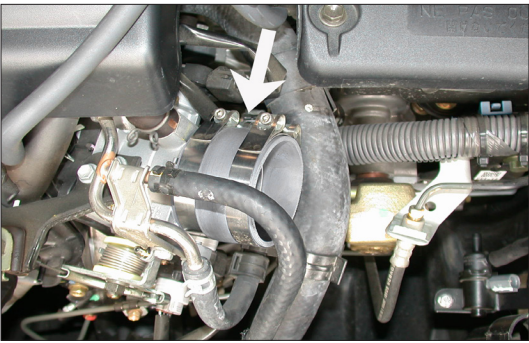

32. Install the silicone hose and hose clamps onto the throttle body as shown.

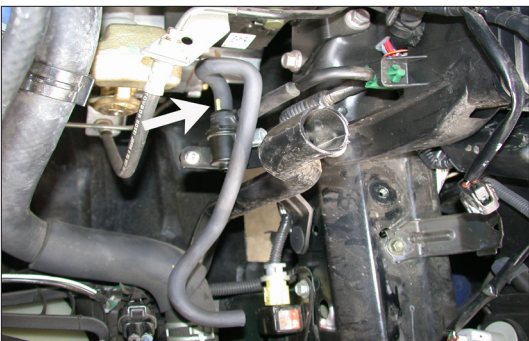

33. Reconnect the vent hose removed in step 23 to the EVAP OBD canister closed valve as shown.

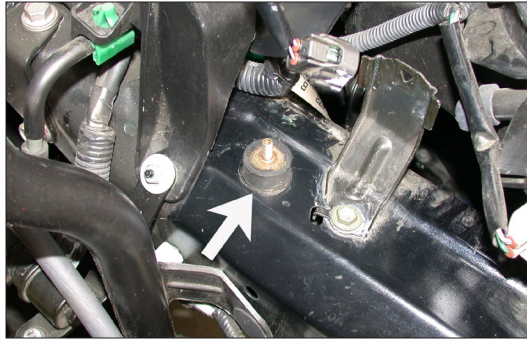

34. Install the provided rubber mounted stud into the existing air cleaner mounting hole as shown.

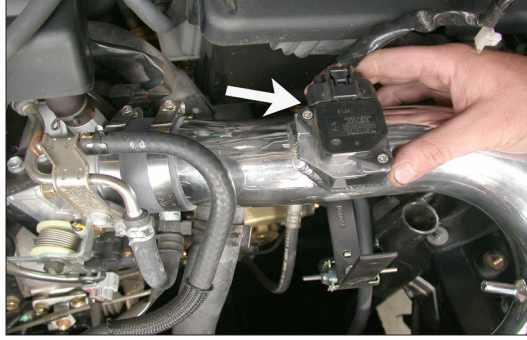

35. While sliding the intake tube into the silicone hose on the throttle body, reconnect the mass air sensor electrical connection as shown.

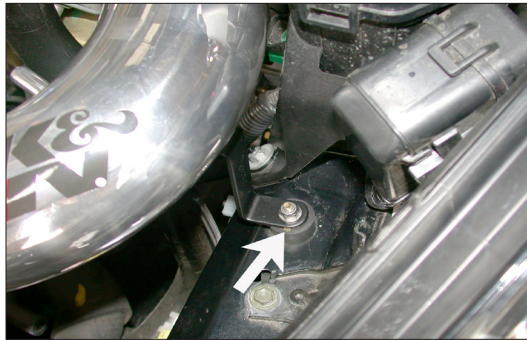

36. Line up the "Z" bracket with the rubber mounted stud and secure it with the provided hardware as shown.

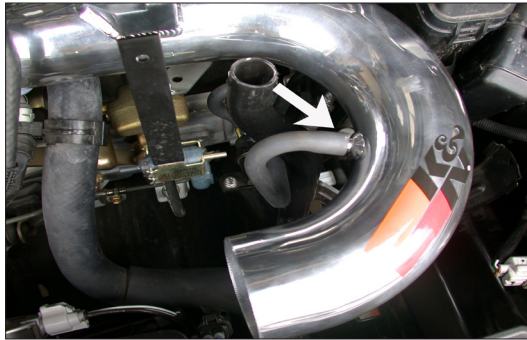

37. Reconnect the EVAP OBD canister closed valve vent hose to the vent on the intake tube as shown.

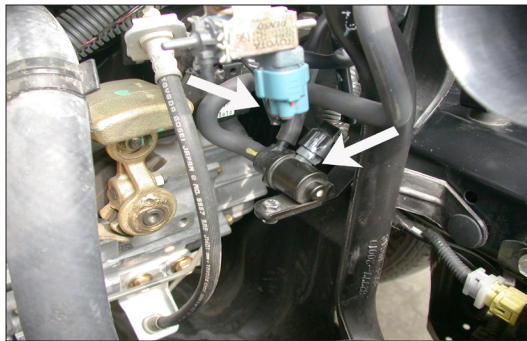

38. Reconnect the EVAP OBD canister closed valve electrical connection and the vacuum switching valve electrical connections as shown.

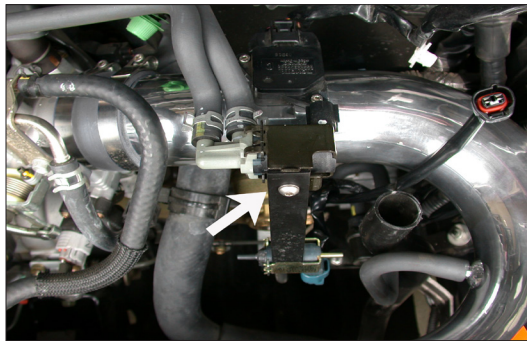

39. Secure the PWM vacuum switching valve to the "L" bracket using the provided hardware as shown

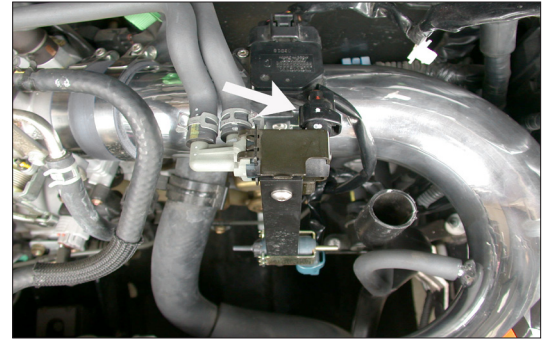

40. Reconnect the PWM vacuum switching valve electrical connection as shown.

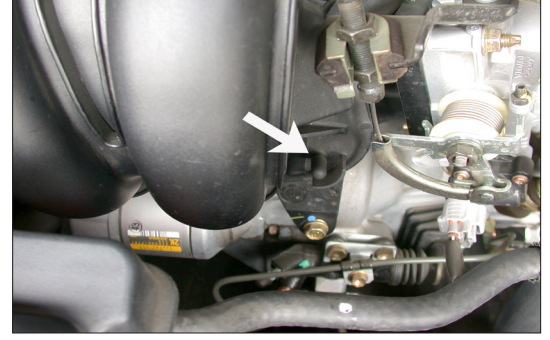

41. Cap the vent on the intake manifold using the provided rubber plug as shown.

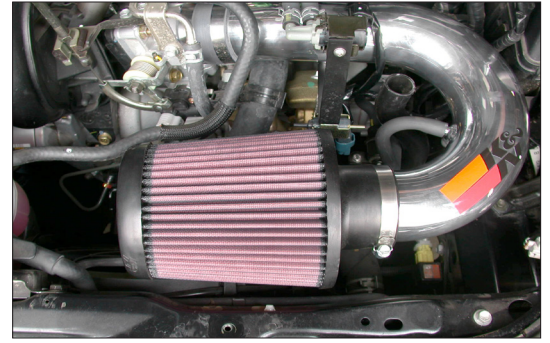

42. Install the air filter onto the intake tube and secure with the provided hose clamp as shown.

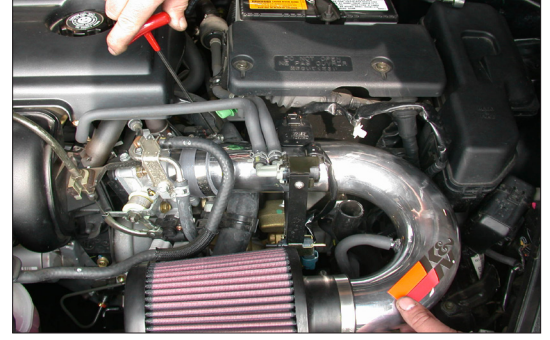

43. Adjust the tube for best fit and clearance and tighten all hardware and hose clamps as shown.

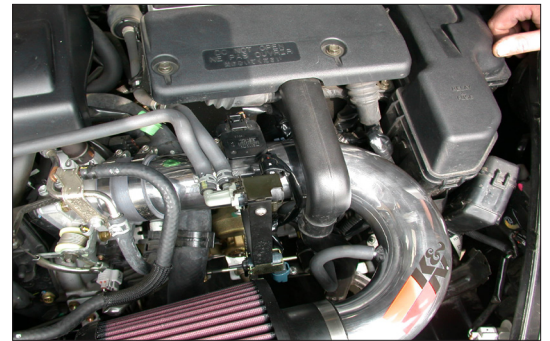

44. Install the computer fresh air tube as shown.

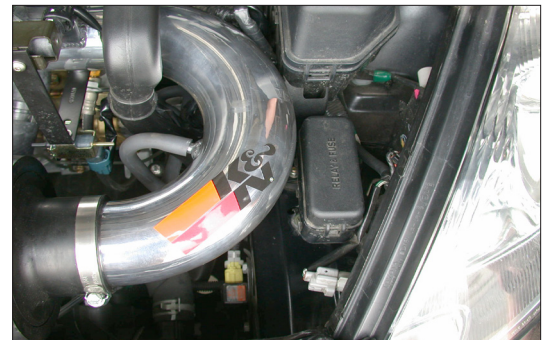

45. Slide the relay and fuse box back onto the stock bracket as shown.



46. Reconnect the vehicle's negative battery cable. Double check to make sure everything is tight and properly positioned before starting the vehicle.

47. The C.A.R.B. exemption sticker, (attached), must be visible under the hood, so the emissions inspector can see it when the vehicle is required to be tested for emissions. California requires testing every two years, other states may vary.

48. It will be necessary for all K&N® high flow intake systems to be checked periodically for realignment, clearance and tightening of all connections. Failure to follow the above instructions or proper maintenance may void warranty.

ROAD TESTING:

1. Start the engine with the transmission in neutral or park, and the parking brake engaged. Listen for air leaks or odd noises. For air leaks secure hoses and connections. For odd noises, find cause and repair before proceeding. This kit will function identically to the factory system except for being louder and much more responsive.

2. Test drive the vehicle. Listen for odd noises or rattles and fix as necessary.

3. If road test is fine, you can now enjoy the added power and performance from your kit.

4. K&N Engineering, Inc., suggests checking the air filter element periodically for excessive dirt build-up. When the element becomes covered in dirt (or once a year), service it according to the instructions on the Recharger® service kit, part number 99-5050 or 99-5000

INTAKE SYSTEMS FOR VEHICLES LISTED ARE 50 STATE LEGAL. SEE KNFILTERS.COM FOR CARB STATUS ON EACH PART FOR A SPECIFIC VEHICLE.